

EC Conventional Carbon Steel Blade Axial Fan

Erp2015
EXCEEDS THE NORM



Φ 630

Rotor Material: Carbon steel
Blade Material: Carbon steel
Ingress Protection: IP54
Insulation Class: F
Bearing Type: Maintenance free ball bearing

Performance Curves

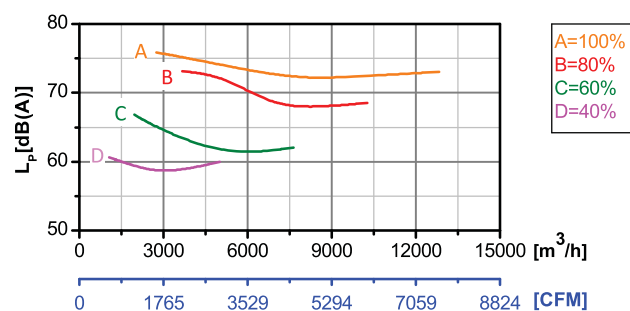
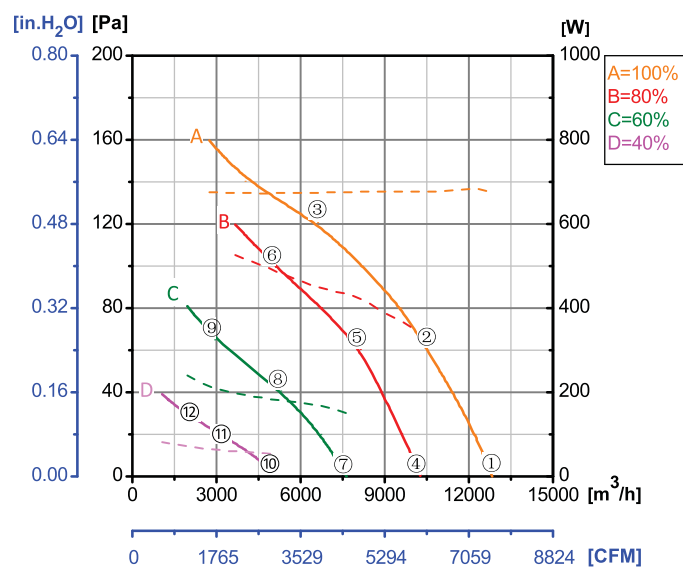

Test Point	Speed	Input Power
	rpm	W
1	1155	673
2	1101	677
3	1051	674
4	927	339
5	931	429
6	930	488
7	694	151
8	695	181
9	695	203
10	467	54
11	465	62
12	466	73

Erp2015 Data:
Efficiency η_{statA} = 37.1%
Efficiency grade N_{actual} = 44.5, N_{target} = 40
Test report No. : L-20210302-004-058

Model No.	Voltage	Frequency	Speed	Input Power	Current	Working Temp.	APPROVALS
	VAC	Hz	RPM	W	A	Min/Max (°C)	
EC137-A630-011	1~220/230	50/60	1160	650	4.20	-20/+60	CCC,CE

Type A

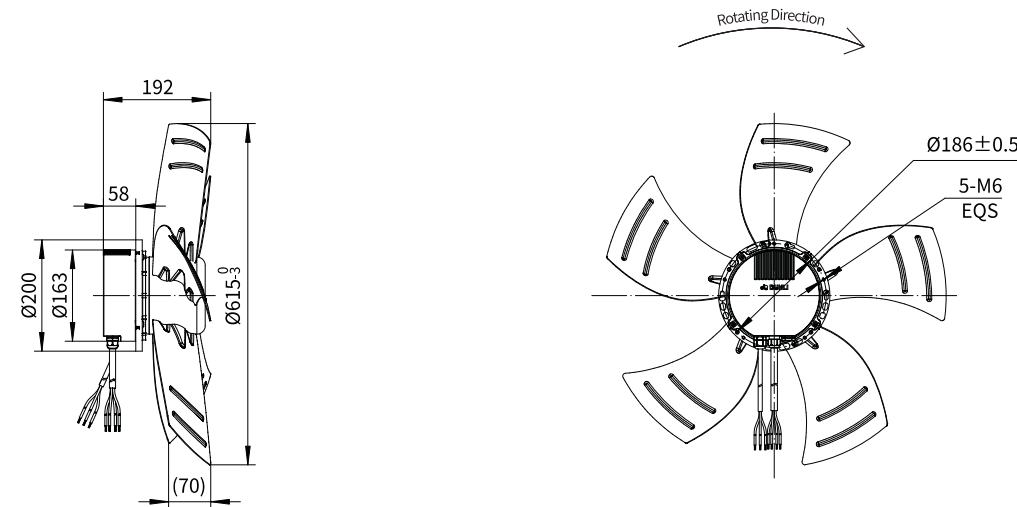

Type D

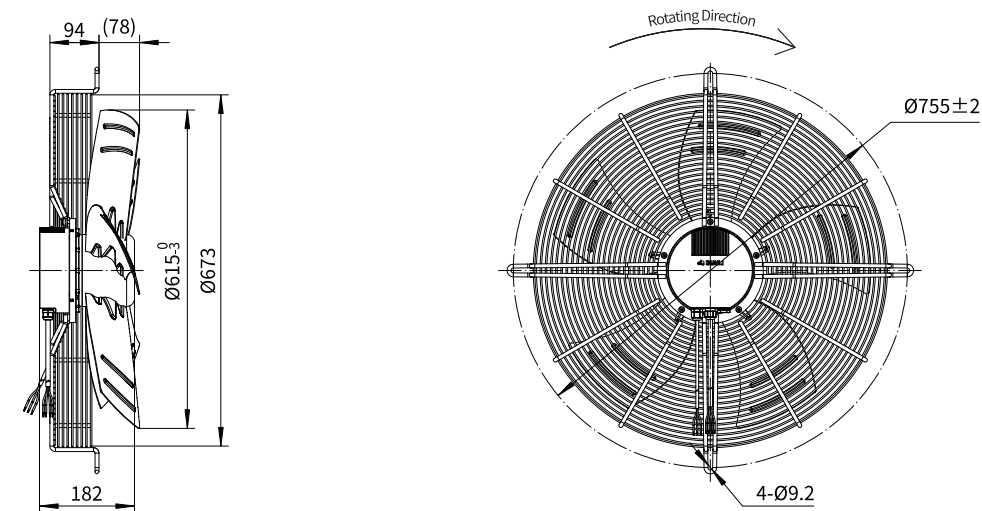

Type F

